

# StingRay and BioRay

With a compact modular design measuring only 19 mm in diameter and using the industries' premier laser diodes, the StingRay delivers best-in-class performance. High-quality glass optics and sophisticated drive electronics deliver the power and control to your application to improve signal-to-noise and measurement speed.

StingRay is the highest-performing top-hat-profile laser available that comes in a variety of fan angles to create the line you need for measurement and profiling applications. Offering the same focus adjustment as the BioRay, the StingRay allows the user to optimize the focus location for the best measurement resolution.

BioRay is a Stingray with an included Heat Sink and Mounting Plate for Life Science applications with an elliptical beam output and a user-adjustable beam divergence (adjustable focus).

With optional RS-232 control the laser power is adjustable as well as onboard diagnostics for operating hours, diode current, output power, temperature, and more.

Select StingRay and BioRay models also include the  $\mu$ Focus and Fiber-Ready (FR) versions.

## FEATURES & BENEFITS

- High Signal-to-Noise with superior Contained Power in the line
- 405 nm to 830 nm
- Power up to 200 mW
- User adjustable focus
- Pointing stability  $<10 \mu\text{rad}/^\circ\text{C}$
- Analog or digital modulation
- Microprocessor controlled
- Onboard diagnostics monitor
- RS-232 control option
- Power supply range: 5 to 24 VDC
- ESD protection, over-temperature protection, and reverse polarity protection
- Optional fiber-ready version

## APPLICATIONS

- Microscopy
- Cytometry
- Medical Imaging and Instrumentation
- Genetics
- High Throughput Screening
- Machine Vision
- 3D Profiling
- Industrial



**LASER OUTPUT SPECIFICATIONS**

Spatial Mode	TEM <sub>00</sub> (Single Transverse Electric Mode)
Beam Quality, M <sup>2</sup> (ModeMaster with 90/10 Clip Level)	<1.5
Pointing Stability over Temperature (μrad/°C)	<10
Beam Angle (boresight) (mrad)	<3
RMS Noise (%) (20 Hz to 20 MHz)	<0.5
Peak-to-Peak Noise (%) (20 Hz to 20 MHz)	<1
Long Term Power Stability (%) (over 8 hours and ±3°C)	<2
Warm-up Time (minutes)	<5

**LASER ELECTRICAL SPECIFICATIONS**

Operating Voltage (V DC)	+5 to +24 (recommend 12 VDC for best efficiency) <sup>1</sup>
Operating Current (mA) (maximum at 25°C)	200
Power-on Delay (seconds) (if enabled)	5
Power Consumption (W)	<5
ESD Protection	EN61326-1 (8 kV Air Discharge, 4 kV Contact Discharge)

**LASER MECHANICAL AND ENVIRONMENTAL SPECIFICATIONS**

Operating Temperature	-10 to 50°C (except 450 nm, 520 nm, and 525 nm with 10°C to 40°C)
Non-Operating (storage) Temperature	-20 to 60°C
Weight (grams) (standard model)	<70
Diameter (mm)	19.05
Material	Aluminum 6061 T1

**LASER WIRING**

Signal	Wire Color	Description
V <sub>in</sub>	Red	Power Supply input for +5 to +24 Volts DC, Recommend 12 VDC <sup>1</sup>
V <sub>in</sub> Ground	Black	Power Supply Ground
Output Signal for Over-Temperature or Over-Current	Green	Open Collector Output, 30 Volts DC maximum, 100 ma current load maximum <sup>2</sup>
V <sub>mod</sub>	Blue	Modulation Input, 5 kOhm input impedance, 5 Volts maximum
V <sub>mod</sub> Ground	Red/Black	Modulation Ground
RS-232 Transmit	Orange	RS-232 Transmit for models with RS-232 option installed
RS-232 Receive	White	RS-232 Receive for models with RS-232 option installed
RS-232 Ground	White/Black	RS-232 Signal Ground for models with RS-232 option installed

<sup>1</sup> Minimum operating voltage for lasers between 400 nm to 525 nm is 6V DC.  
<sup>2</sup> Not available on Fast Digital Modulation (FT or RFT models).

## CHOOSE YOUR LASER

The StingRay and BioRay products come in a variety of wavelength, output power, and configuration options.

Use the following simple ten-step selection guide to choose the ideal laser and features for your application. Refer to the last page for our most popular versions, their part numbers, and pricing available for immediate delivery.

Configure your laser with these ten steps:

**STEP 1:** Package

**STEP 2:** Wavelength

**STEP 3:** Output Power

**STEP 4:** Output Power Control Mode

**STEP 5:** Beam Shape

**STEP 6:** Focus Distance

**STEP 7:** Communication Option (RS-232)

**STEP 8:** Cable Length/Connector



**STEP 9:** Data Report

**STEP 10:** Power-On Delay



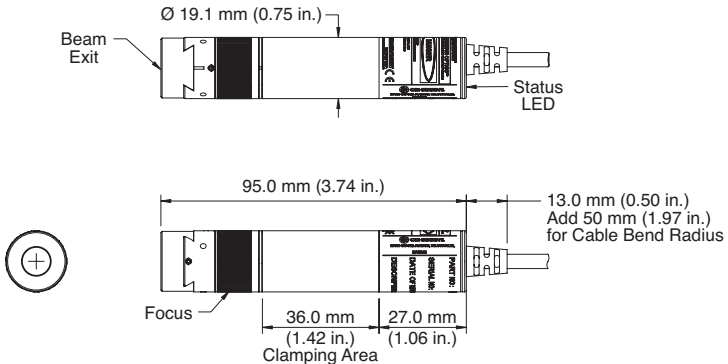

**STEP 1:**

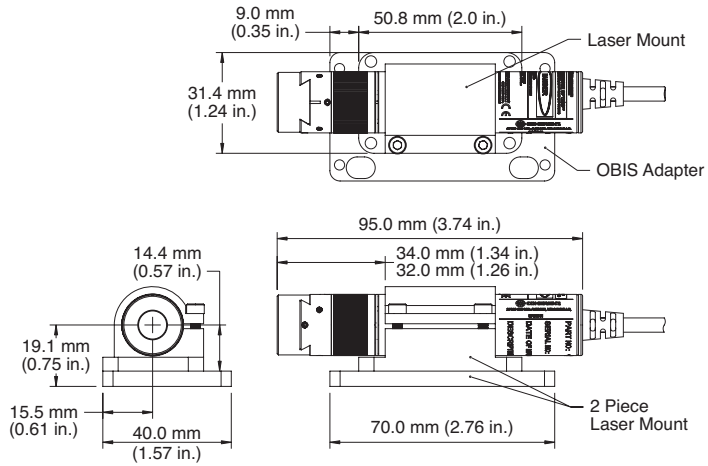
Choose your package with optional separated electronics, mounts, and/or fiber attachment.  
Choose only one option from the following selections.

Standard StingRay	Mechanical Specifications <sup>1</sup>
<input type="checkbox"/> 	
StingRay in Mount, BioRay	Mechanical Specifications <sup>1</sup>
<input type="checkbox"/> 	

<sup>1</sup> For more dimension details and CAD drawings, please visit [www.coherent.com](http://www.coherent.com)

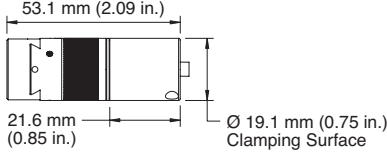
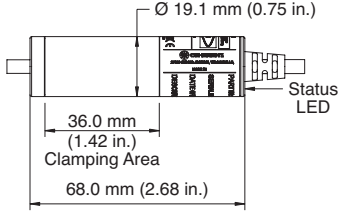
**STEP 1 (continued):**

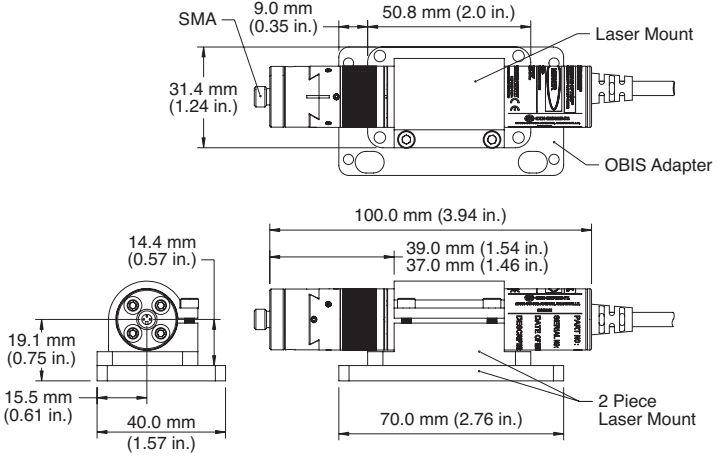
Separate Driver, Compact Laser Head	Mechanical Specifications <sup>1</sup>
<p>(select cable length between laser head and driver)</p> <p><input type="checkbox"/> 75 mm <input type="checkbox"/> 150 mm <input type="checkbox"/> 250 mm <input type="checkbox"/> 500 mm</p> 	<p><b>Laser Head</b></p>  <p><b>Driver</b></p> 
BioRay FR (Fiber-Ready with SMA)	Mechanical Specifications <sup>1</sup>
<p><input type="checkbox"/></p> 	

<sup>1</sup> For more dimension details and CAD drawings, please visit [www.coherent.com](http://www.coherent.com)

**STEP 2:**

Choose your wavelength.

Choose only one of the following selections.

Wavelength Choices <sup>1</sup> (nm)	405	450	488	520	525	639	640	655	660	685	785	830
	<input type="checkbox"/>	<input type="checkbox"/>	<input type="checkbox"/>	<input type="checkbox"/>	<input type="checkbox"/>	<input type="checkbox"/>	<input type="checkbox"/>	<input type="checkbox"/>	<input type="checkbox"/>	<input type="checkbox"/>	<input type="checkbox"/>	<input type="checkbox"/>

<sup>1</sup> BioRay FR available in 405 nm, 450 nm, 488 nm and 640 nm. StingRay and BioRay Laser-to-laser wavelength tolerance of 405 nm is ±5 nm, 450 nm is ±10 nm, 488 nm is ±10 nm, 520 nm is 510 nm to 530 nm, 525 nm is 520 nm to 530 nm, 639 nm is 635 nm to 648 nm, 640 nm is ±6 nm, 647 nm is ±5 nm, 655 nm is 650 nm to 665 nm, 660 nm for ≥50 mW is 655 to 665 nm, 660 nm for <50 mW is 652 to 662 nm, 685 is ±15 nm, 785 nm is ±19 nm, 830 nm is 815 nm to 845 nm.

**STEP 3:**

Choose your power.

Choose only one of the following selections.

Wavelength Choices <sup>1</sup> (nm)	405	450	488	520	525	639	640	655	660	685	785	830
Output Power Available (mW)												
1						<input type="checkbox"/>		<input type="checkbox"/>				
5				<input type="checkbox"/>	<input type="checkbox"/>	<input type="checkbox"/>		<input type="checkbox"/>				
10		<input type="checkbox"/>		<input type="checkbox"/>	<input type="checkbox"/>	<input type="checkbox"/>			<input type="checkbox"/>			
20	<input type="checkbox"/>	<input type="checkbox"/>	<input type="checkbox"/>	<input type="checkbox"/>	<input type="checkbox"/>		<input type="checkbox"/>		<input type="checkbox"/>	<input type="checkbox"/>	<input type="checkbox"/>	
25					<input type="checkbox"/>							
35	<input type="checkbox"/>	<input type="checkbox"/>		<input type="checkbox"/>			<input type="checkbox"/>		<input type="checkbox"/>	<input type="checkbox"/>	<input type="checkbox"/>	
50	<input type="checkbox"/>	<input type="checkbox"/>	<input type="checkbox"/>	<input type="checkbox"/>	<input type="checkbox"/>				<input type="checkbox"/>	<input type="checkbox"/>	<input type="checkbox"/>	
75					<input type="checkbox"/>						<input type="checkbox"/>	<input type="checkbox"/>
90											<input type="checkbox"/>	
100	<input type="checkbox"/>						<input type="checkbox"/>		<input type="checkbox"/>			<input type="checkbox"/>
140									<input type="checkbox"/>			
150												<input type="checkbox"/>
180									<input type="checkbox"/>			
200												<input type="checkbox"/>

<sup>1</sup> BioRay FR (Fiber-Ready) only available in 405 nm 50 mW, 450 nm 50 mW, 488 nm 20 mW and 640 nm 40 mW. BioRay FR offers >70% coupling efficiency with NA=0.22 into a customer-provided 50 µm or 100 µm fiber.

**STEP 4:**

Choose your output power control: CW, analog modulation (variable output power), or digital modulation.  
Choose only one of the following selections.

CW Mode	Function
<input type="checkbox"/> Continuous Wave (CW)	Constant power mode Laser on at full power User can adjust laser output power and monitor power through RS-232 option (if enabled) No modulation input required
Analog Modulation <sup>1</sup>	Function
<input type="checkbox"/> Analog (A)	Input <0.5V = output power is off, Input = 5V is 100% output power, 0.5V to 5V is linear power control from external voltage source  Bandwidth of 500 kHz Rise time (10% to 90%) <1 μsec, 500 nsec (typ.) Fall time (90% to 10%) <1 μsec, 500 nsec (typ.)  Analog Modulation can be used with a DC voltage input to simply vary the output power
<input type="checkbox"/> Reverse Analog (RA)	Input >4.5V = output power is off, Input = 0V is 100% output power, 4.5V to 0V is linear power control from external voltage source  Bandwidth of 500 kHz Rise time (10% to 90%) <1 μsec, 500 nsec (typ.) Fall time (90% to 10%) <1 μsec, 500 nsec (typ.)  Reverse Analog Modulation can be used with a DC voltage input to simply vary the output power

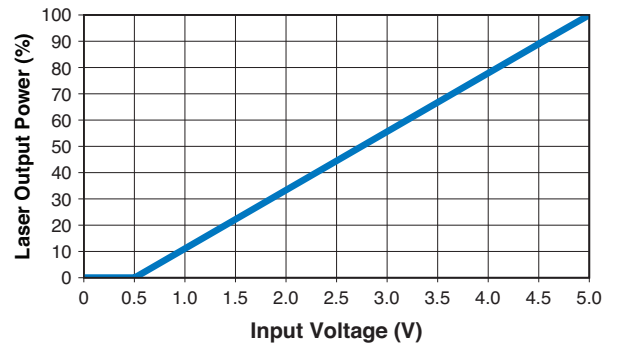

No adjustable output power through RS-232

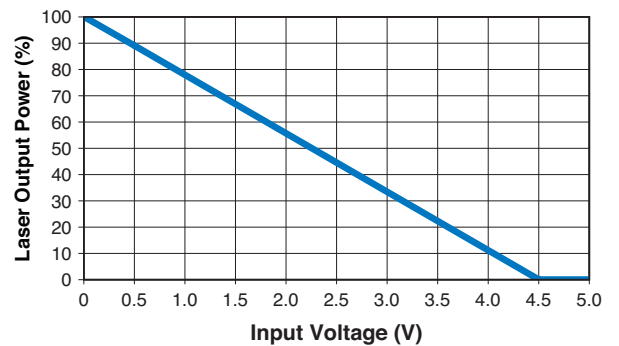

No adjustable output power through RS-232

<sup>1</sup> BioRay is standard with Analog Modulation and will require a 5V input signal to operate.

**STEP 4 (continued):**

Digital Modulation	Function
<input type="checkbox"/> Digital TTL (T)  <input type="checkbox"/> Fast Digital TTL (FT)	<p>Input 0V to 1V is output power off, Input 4V to 5V is 100% output power</p> <p>Bandwidth of 100 kHz Rise time (10% to 90%) &lt;1 μsec, 500 nsec (typ.) Fall time (90% to 10%) &lt;1 μsec, 500 nsec (typ.)</p> <p>Bandwidth of 2 MHz Rise time (10% to 90%) &lt;150 nsec Fall time (90% to 10%) &lt;150 nsec</p>
<input type="checkbox"/> Reverse Digital TTL (RT)  <input type="checkbox"/> Reverse Fast Digital TTL (RFT)	<p>Input 0V to 1V is 100% output power, Input 4V to 5V is 0% output power</p> <p>Bandwidth of 100 kHz Rise time (10% to 90%) &lt;1 μsec, 500 nsec (typ.) Fall time (90% to 10%) &lt;1 μsec, 500 nsec (typ.)</p> <p>Bandwidth of 2 MHz Rise time (10% to 90%) &lt;150 nsec Fall time (90% to 10%) &lt;150 nsec</p>

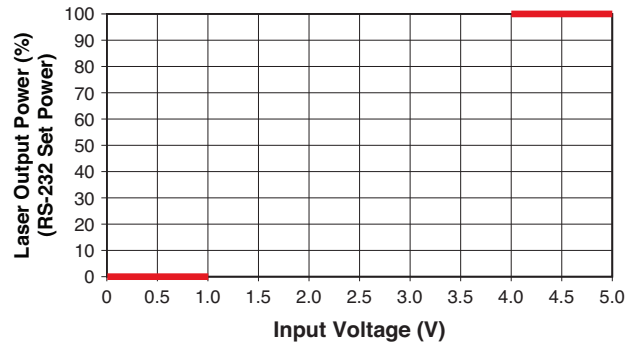

User can adjust output power setting through RS-232 option (if enabled)

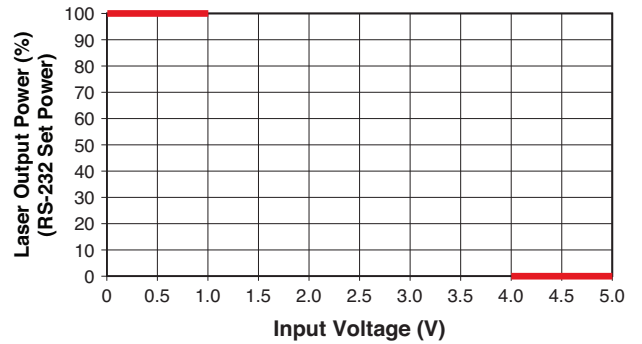

User can adjust output power setting through RS-232 option (if enabled)



**STEP 5:**

Choose your beam shape.

Choose only one of the following selections.

**Elliptical Dot Beam**

D01 – Coherent’s high-quality elliptical collimated beam with user adjustable focus to change the beam divergence.

- D01-XX, Standard ~1 mm by ~3 mm beam diameter



MicoFocus  $\mu$ FL D01 – Coherent’s high-quality elliptical collimated beam with user adjustable focus to change the beam divergence. Large diameter beam allows for tighter focus spots.

- $\mu$ FL D01-XX, Large beam diameter 2X with less divergence

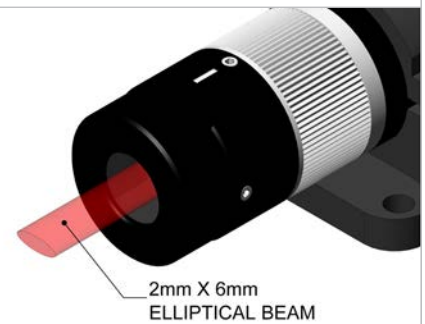

**Line Beam Generator**

L01 – Coherent’s Premier Flat-Top Line Technology, with nine choices for the fan angle at which the line expands out from the laser.

- L01-1 Line with 1 degree fan angle
  - Fan angle 1° with tolerance  $\pm 10\%$
  - Relative intensity floor >75%
  - Contained Power  $\geq 90\%$
  - Note: Not available in 488 nm



- L01-5 Line with 5 degree fan angle
  - Fan angle 5° with tolerance  $\pm 10\%$
  - Straightness <0.1%
  - Relative intensity floor >75%
  - Contained Power  $\geq 95\%$
  - Note: Not available in 488 nm

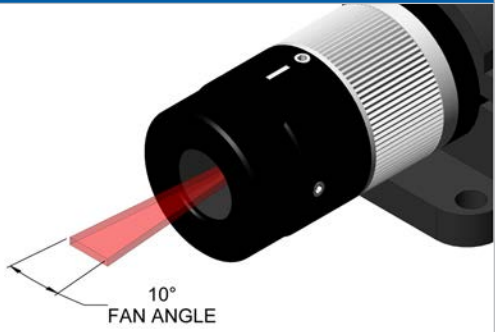
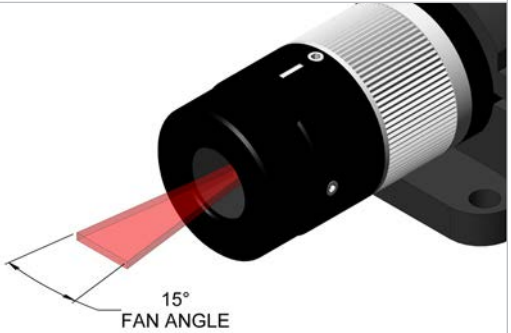
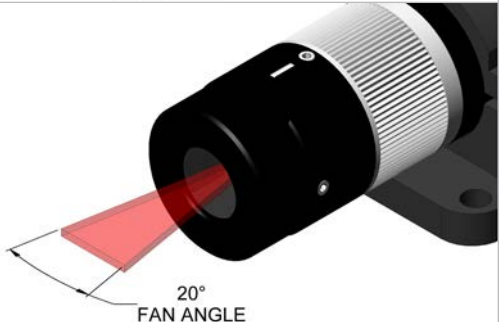
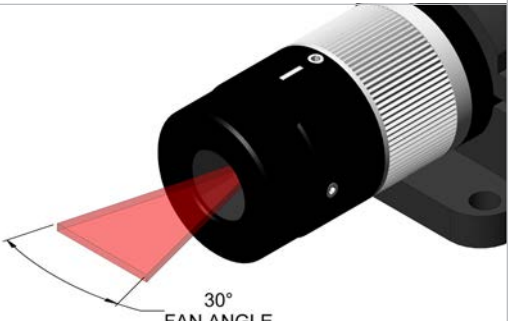

**STEP 5 (continued):**

<b>Line Beam Generator (cont.)</b>	
<p><input type="checkbox"/> L01-10 Line with 10 degree fan angle</p> <p>Fan angle 10° with tolerance ±5%                      Straightness &lt;0.1%                      Relative intensity floor &gt;75%                      Contained Power ≥95%</p> <p>Note: Not available in 488 nm</p>	 <p>10° FAN ANGLE</p>
<p><input type="checkbox"/> L01-15 Line with 15 degree fan angle</p> <p>Fan angle 15° with tolerance ±5%                      Straightness &lt;0.1%                      Relative intensity floor &gt;75%                      Contained Power ≥95%</p> <p>Note: Not available in 488 nm</p>	 <p>15° FAN ANGLE</p>
<p><input type="checkbox"/> L01-20 Line with 20 degree fan angle</p> <p>Fan angle 20° with tolerance ±5%                      Straightness &lt;0.1%                      Relative intensity floor &gt;75%                      Contained Power ≥95%</p> <p>Note: Only available for wavelengths 520 nm to 785 nm</p>	 <p>20° FAN ANGLE</p>
<p><input type="checkbox"/> L01-30 Line with 30 degree fan angle</p> <p><input type="checkbox"/> L01-30 Line with 30 degree fan angle, micro-focus (μFL)</p> <p>Fan angle 30° with tolerance ±5%                      Straightness &lt;0.1%                      Relative intensity floor &gt;75%                      Contained Power ≥95%</p> <p>Note: Not available in 488 nm. Micro-focus (μFL) only available in 520 nm to 785 nm.</p>	 <p>30° FAN ANGLE</p>

**STEP 5 (continued):**

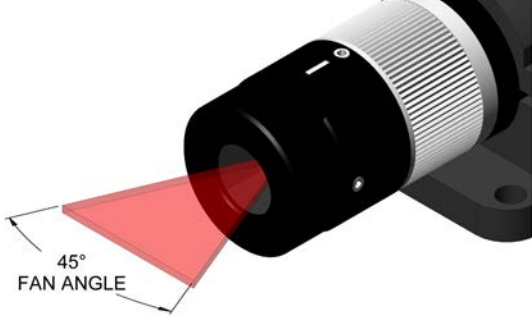
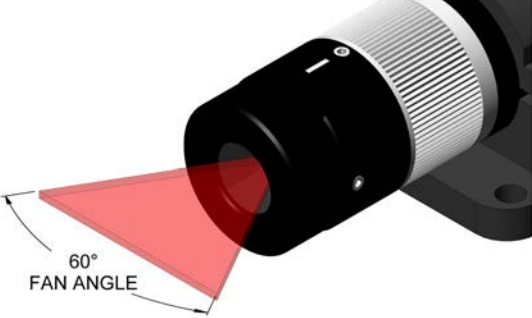
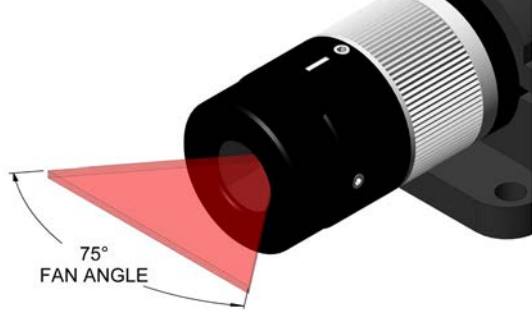
Line Beam Generator (cont.)	
<ul style="list-style-type: none"> <li><input type="checkbox"/> L01-45 Line with 45 degree fan angle</li> <li><input type="checkbox"/> L01-45 Line with 45 degree fan angle, micro-focus (<math>\mu</math>FL)</li> </ul> <p>Fan angle <math>45^\circ</math> with tolerance <math>\pm 5\%</math>                      Straightness <math>&lt;0.1\%</math>                      Relative intensity floor <math>&gt;60\%</math>                      Contained Power <math>\geq 95\%</math></p> <p>Note: Not available in 488 nm. Micro-focus (<math>\mu</math>FL) only available in 520 nm to 785 nm.</p>	
<ul style="list-style-type: none"> <li><input type="checkbox"/> L01-60 Line with 60 degree fan angle</li> <li><input type="checkbox"/> L01-60 Line with 60 degree fan angle, micro-focus (<math>\mu</math>FL)</li> </ul> <p>Fan angle <math>60^\circ</math> with tolerance <math>\pm 5\%</math>                      Straightness <math>&lt;0.1\%</math>                      Relative intensity floor <math>&gt;60\%</math>                      Contained Power <math>\geq 95\%</math></p> <p>Note: Not available in 488 nm. Micro-focus (<math>\mu</math>FL) only available in 520 nm to 785 nm.</p>	
<ul style="list-style-type: none"> <li><input type="checkbox"/> L01-75 Line with 75 degree fan angle</li> </ul> <p>Fan angle <math>75^\circ</math> with tolerance <math>\pm 5\%</math>                      Straightness <math>&lt;0.1\%</math>                      Relative intensity floor <math>&gt;50\%</math>                      Contained Power <math>\geq 95\%</math></p> <p>Note: Not available in 488 nm</p>	

**GLOSSARY OF TERMS:**

Definition	Description
Fan Angle or Line Length	Length of flat top profile, measured at 80% intensity clip levels. Reported in degrees for the fan angle.
Straightness	Maximum deviation from the best fit line. Measured as the delta from the best fit line divided by the line length. Reported as a percentage.
Relative Intensity Floor	Minimum relative intensity at any point along the line length. Reported as a relative intensity.
Contained Power	Power contained within the defined Flat Top.

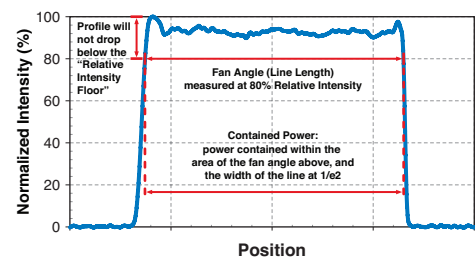

Note: Line is optimized in the factory at 500 mm working distance from laser

**STEP 6:**

Choose your focus distance (Coherent can preset the adjustable focus).

Choose only one of the following selections.

Focus	Description
<input type="checkbox"/> Standard, Default, 500 mm	Adjustable focus feature factory set for best focus at 500 mm distance from laser. You can readjust and lock as needed.
<input type="checkbox"/> Custom, _____ mm	Choose from a 50 mm up to a 2000 mm focus distance. Adjustable focus feature factory set to your specified distance from laser. You can readjust and lock as needed. Choosing 2000 mm is "collimated".

**STEP 7:**

Choose your communication option (RS-232).

Choose only one option of following selections.

Focus	Description
<input type="checkbox"/> None	No communications. RS-232 disabled.
<input type="checkbox"/> RS-232	RS-232 enabled for laser control and status. Can monitor hours, power and temperature. Can adjust laser output power for CW and digital modulation modes.

**STEP 8:**

Choose your cable length and connector/pinout.

Choose only one of the following selections.

Code	Description	Image	Connection	
FL	<p><b>Flying Leads</b></p> <p>Choose Length (mm)</p> <p><input type="checkbox"/> 250</p> <p><input type="checkbox"/> 500</p> <p><input type="checkbox"/> 1000</p> <p><input type="checkbox"/> 1500</p> <p><input type="checkbox"/> 2000</p> <p><input type="checkbox"/> 2500</p>		<p><math>V_{in}</math></p> <p><math>V_{in}</math> Ground</p> <p>Fault</p> <p><math>V_{mod}</math></p> <p><math>V_{mod}</math> Ground</p> <p>RS-232 Transmit</p> <p>RS-232 Receive</p> <p>RS-232 Ground</p>	<p>Red</p> <p>Black</p> <p>Green</p> <p>Blue</p> <p>Red/Black</p> <p>Orange</p> <p>White</p> <p>White/Black</p>
HR	<p><b>Hirose R10A-10P-12SC(73)</b></p> <p><input type="checkbox"/> 1000 mm</p>		<p><math>V_{in}</math></p> <p><math>V_{in}</math> Ground</p> <p>Fault</p> <p><math>V_{mod}</math></p> <p><math>V_{mod}</math> Ground</p> <p>RS-232 Transmit</p> <p>RS-232 Receive</p> <p>RS-232 Ground</p>	<p>9</p> <p>1</p> <p>10</p> <p>2</p> <p>3</p> <p>6</p> <p>4</p> <p>5</p>
P	<p><b>Power Plug, Phono 3.5 mm</b></p> <p><input type="checkbox"/> 500 mm</p> <p>Note: Only for CW mode</p>		<p><math>V_{in}</math></p> <p><math>V_{in}</math> Ground, Shield</p> <p>Fault</p> <p><math>V_{mod}</math></p> <p><math>V_{mod}</math> Ground</p> <p>RS-232 Transmit</p> <p>RS-232 Receive</p> <p>RS-232 Ground</p>	<p>Tip</p> <p>Base</p> <p>No Connection</p> <p>No Connection</p> <p>No Connection</p> <p>No Connection</p> <p>No Connection</p> <p>No Connection</p>
B	<p><b>Power Plug, Phono 3.5 mm and BNC for Modulation</b></p> <p><input type="checkbox"/> 500 mm</p> <p>Note: Do not order with CW mode</p>		<p><math>V_{in}</math></p> <p><math>V_{in}</math> Ground, Shield</p> <p>Fault</p> <p><math>V_{mod}</math></p> <p><math>V_{mod}</math> Ground</p> <p>RS-232 Transmit</p> <p>RS-232 Receive</p> <p>RS-232 Ground</p>	<p>Phono Plug Tip</p> <p>Phono Plug Base</p> <p>No Connection</p> <p>BNC Tip</p> <p>BNC Base</p> <p>No Connection</p> <p>No Connection</p> <p>No Connection</p>

**STEP 9:**

Choose data report.

Data Reports	Description
<input checked="" type="checkbox"/> Basic	Every laser includes a final quality test report
<input type="checkbox"/> Line Data	Add uniformity and straightness data for lines (L01)

**STEP 10:**

Choose five-second start-up power-on delay.

Choose only one of the following selections.

Power-on Delay	Description
<input type="checkbox"/> None	Laser will start emission at power-on
<input type="checkbox"/> Yes, default	Laser will have an approximate five-second delay for laser emission after power-on

**CONGRATULATIONS:**

You have completed the laser configuration steps! Please email this to your local Coherent Sales representative to get a quote on price and delivery. You can also view our most popular models on the next two pages.

## MOST POPULAR CONFIGURATIONS:

Part Number	Description
1264213	<b>BioRay 405 nm 50 mW Elliptical Dot Laser</b> Analog Modulation enabled, Includes mount, 1 meter cable and Hirose connector, typical 1x3 mm collimated beam
1264214	<b>BioRay 450 nm 50 mW Elliptical Dot Laser</b> Analog Modulation enabled, Includes mount, 1 meter cable and Hirose connector, typical 1x3 mm collimated beam
1270002	<b>BioRay 488 nm 20 mW Elliptical Dot Laser</b> Analog Modulation enabled, Includes mount, 1 meter cable and Hirose connector, typical 1x3 mm collimated beam
1264216	<b>BioRay 520 nm 50 mW Elliptical Dot Laser</b> Analog Modulation enabled, Includes mount, 1 meter cable and Hirose connector, typical 1x3 mm collimated beam
1264218	<b>BioRay 640 nm 40 mW Elliptical Dot Laser</b> Analog Modulation enabled, Includes mount, 1 meter cable and Hirose connector, typical 1x3 mm collimated beam
1286584	<b>STR-520-20-CW-FL-L01-75-S-XX-3, CDRH Class II</b> StingRay, 520 nm, 20 mW, Single Line, 75° Fan Angle, Pre-focused to 500 mm distance, 5-second Power-on Delay, 500 mm cable with Flying Leads
1253606	<b>STR-520-35-CW-FL-D01-XX-S-TX</b> StingRay, 520 nm, 35 mW, Elliptical Dot Beam, Pre-focused to 500 mm distance, 5-second Power-on Delay, 500 mm cable with Flying Leads, Includes RS-232 communications
1285005	<b>STR-639-5-CW-FL-L01-20-S-XX-8</b> StingRay, 639 nm, 5 mW, Single Line, 20° Fan Angle, Pre-focused to 500 mm distance, 500 mm cable with Flying Leads. NOTE: Does not have 5-second power-on delay for laser emission.
1276557	<b>STR-639-5-CW-FL-L01-45-S-XX-8</b> StingRay, 639 nm, 5 mW, Single Line, 45° Fan Angle, Pre-focused to 500 mm distance, 500 mm cable with Flying Leads. NOTE: Does not have 5-second power-on delay for laser emission.
1277105	<b>STR-639-10-CW-P-L01-75-E-XX</b> StingRay, 639 nm, 10 mW, Single Line, 75° Fan Angle, Pre-focused to 500 mm distance, Extended Depth of Focus, 500 mm cable with Flying Leads
1262766	<b>STR-660-10-CW-FL-L01-10-S-XX-8</b> StingRay, 660 nm, 10 mW, Single Line, 10° Fan Angle, Pre-focused to 500 mm distance, 500 mm cable with Flying Leads. NOTE: Does not have 5-second power-on delay for laser emission.
1255565	<b>STR-660-10-A-FL-L01-20-E-XX</b> StingRay, 660 nm, 10 mW, Single Line, 20° Fan Angle, Pre-focused to 500 mm distance, Extended Depth of Focus, 500 mm cable with Flying Leads, Analog Modulation enabled
1258287	<b>STR-660-10-CW-FL-L01-60-S-TX</b> StingRay, 660 nm, 10 mW, Single Line, 60° Fan Angle, Pre-focused to 500 mm distance, 500 mm cable with Flying Leads, Includes RS-232 communications
1289028	<b>STR-660-35-CW-HR-L01-1-S-XX-8</b> StingRay, 660 nm, 10 mW, Single Line, 1° Fan Angle, Pre-focused to 500 mm distance, ~1 Meter cable with Hirose Connector. NOTE: Does not have 5-second power-on delay for laser emission.

**MOST POPULAR CONFIGURATIONS (continued):**

Part Number	Description
1288507	<b>STR-660-35-CW-HR-L01-20-S-XX-8</b> StingRay, 660 nm, 35 mW, Single Line, 20° Fan Angle, Pre-focused to 500 mm distance, ~1 Meter cable with Hirose Connector. NOTE: Does not have 5-second power-on delay for laser emission.
1280731	<b>STR-660-100-T-FL-L01-10-S-TX</b> StingRay, 660 nm, 100 mW, Single Line, 10° Fan Angle, Pre-focused to 500 mm distance, ~1 Meter cable with Hirose Connector, Digital Modulation enabled, Includes RS-232 communications
1280028	<b>STR-660-100-T-HR-L01-15-E-TX-5</b> Stingray, Separate Driver (Enclosed) with 150 mm between laser and driver, 660 nm, 100 mW, Single Line, 15° Fan Angle, Pre-focused to 500 mm distance, Extended Depth of Focus, ~1 Meter cable with Hirose Connector, Digital Modulation enabled, Includes RS-232 communications
1280027	<b>STR-660-100-T-HR-L01-30-E-TX-5</b> Stingray, Separate Driver (Enclosed) with 150 mm between laser and driver, 660 nm, 100 mW, Single Line, 30° Fan Angle, Pre-focused to 500 mm distance, Extended Depth of Focus, ~1 Meter cable with Hirose Connector, Digital Modulation enabled, Includes RS-232 communications
1285314	<b>STR-660-100-CW-HR-L01-45-S-XX-8</b> StingRay, 660 nm, 100 mW, Single Line, 45° Fan Angle, Pre-focused to 500 mm distance, ~1 Meter cable with Hirose Connector. NOTE: Does not have 5-second power-on delay for laser emission.
1262526	<b>STR-660-100-CW-FL-L01-60-S-XX</b> StingRay, 660 nm, 100 mW, Single Line, 60° Fan Angle, Pre-focused to 500 mm distance, 500 mm cable with Flying Leads
1286514	<b>STR-785-90-T-FL-D01-XX-S-XX</b> StingRay, 785 nm, 90 mW, Elliptical Dot Beam, Pre-focused to 500 mm distance, 500 mm cable with Flying Leads
1231404	<b>StingRay Controller with Keyswitch and Interlock</b> Accessory for enhanced integration. Includes control software and power supply. Use with lasers that include a Hirose connector. For more details, refer to the StingRay Accessory datasheet.



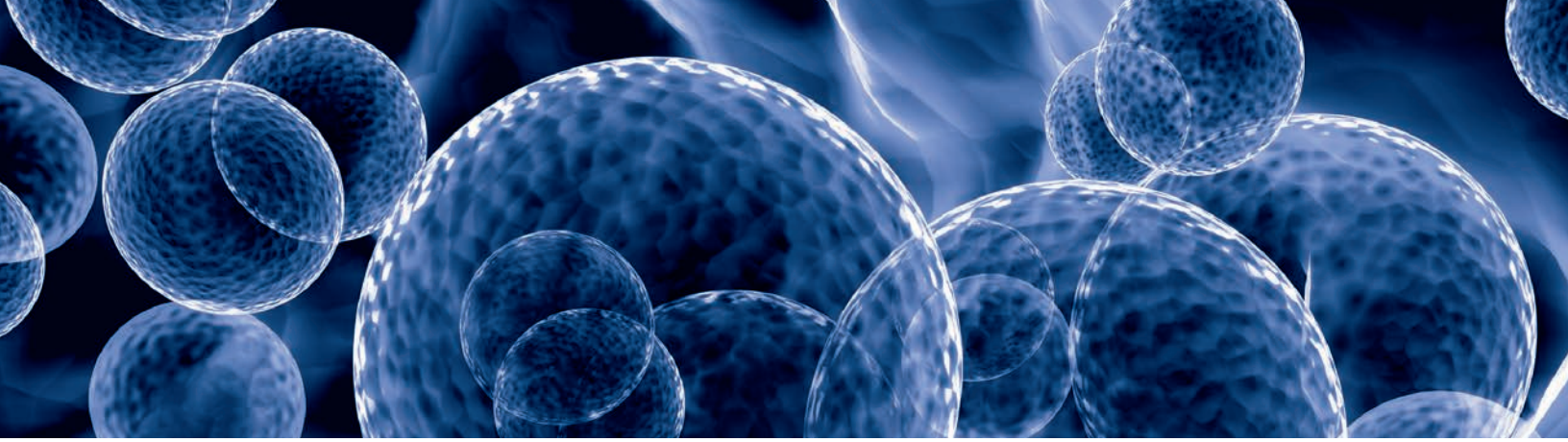

# StingRay Accessories

The StingRay laser is the highest-performing laser available for measurement and profiling applications with a variety of accessories help accelerate your integration. Accessories include mounting options, remotes, and cabling.

## FEATURES

- Laser Power Supply
- Multi-Axis Mount
- Heat Sink Mount
- Mount Adapter Plate
- StingRay Remote
- CDRH Controller Kit
- CDRH Controller Power Supply
- 12 Pin Hirose to Flying Lead Connector
- Connection Software



### StingRay Power Supply

**Part Number: 1232091**

The StingRay Power Supply is designed to power the StingRay laser and includes the power adaptor and the power cord.

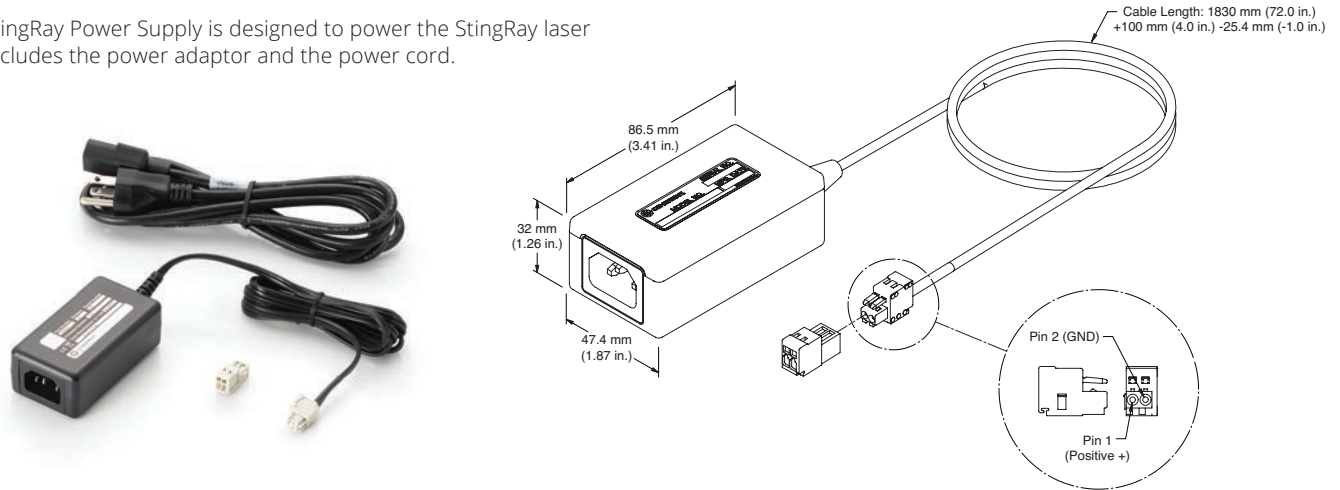

### StingRay Multi-Axis Mount

**Part Number: 1280838**

The StingRay Multi-Axis Mount provides the user/integrator with the capability of precision movement/alignment of the laser as it is installed into an instrument or application.

This movement consists of:

- 360-degree rotation about the laser's mechanical axis
- Tilt about the x-axis up to seven degrees

The StingRay Multi-Axis Mount provides multiple mounting options for the user, conforming to the standard StingRay/OBIS footprint. It also allows for more general mounting with two machined slots for quick installation.

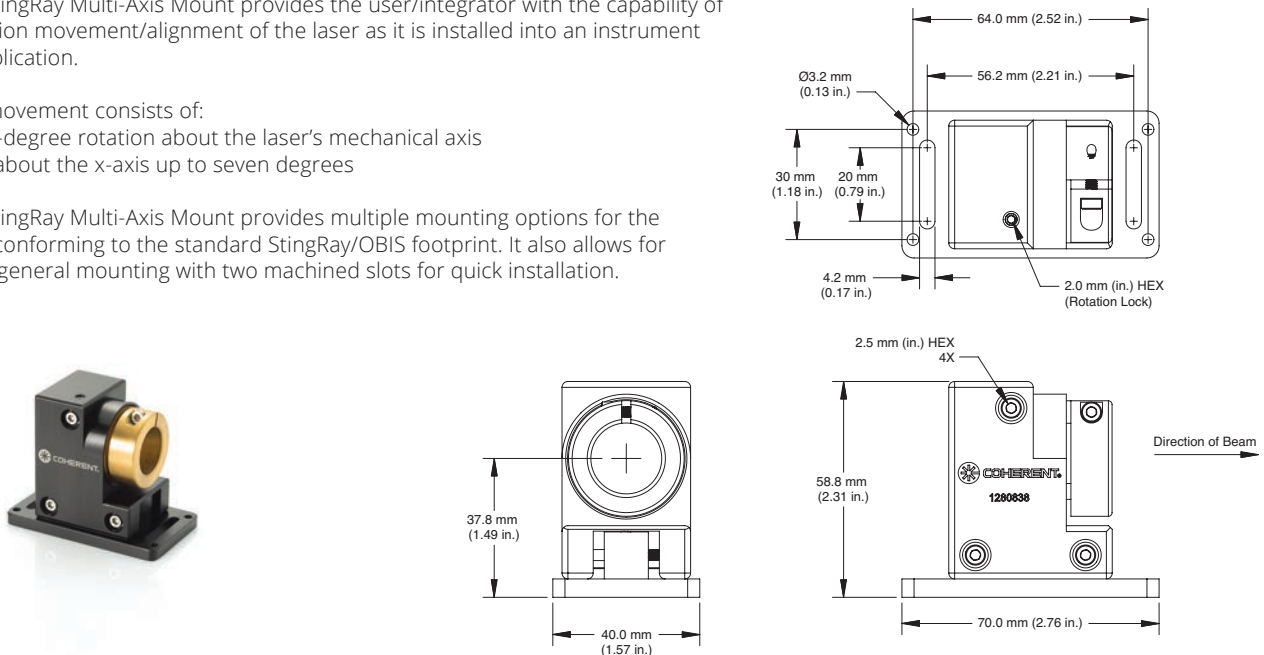

### StingRay Heat Sink Mount

Part Number: 1222896

This mount is specifically designed to match the thermal management design employed in the StingRay laser family. This product offers excellent thermal and pointing stability. The mount includes four thru holes and four tapped holes with a precision pin slot for easy and repeatable mounting.



Example of Stingray Laser in the Mount

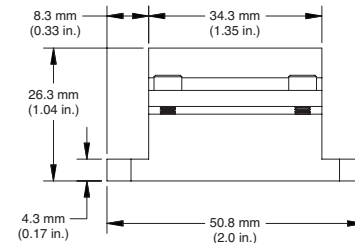
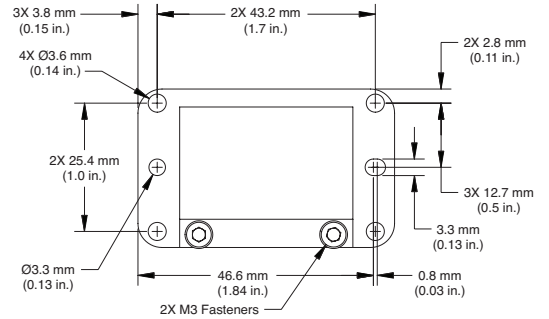
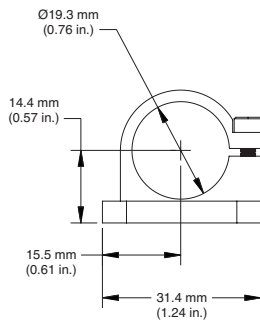
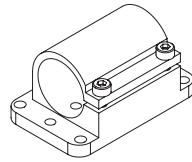

### StingRay Mount Adapter Plate

Part Number: 1222894

The StingRay Heat Sink Mount Adapter Plate enables the user to adapt the StingRay to metric or English optical table or base plate for quick and easy integration.

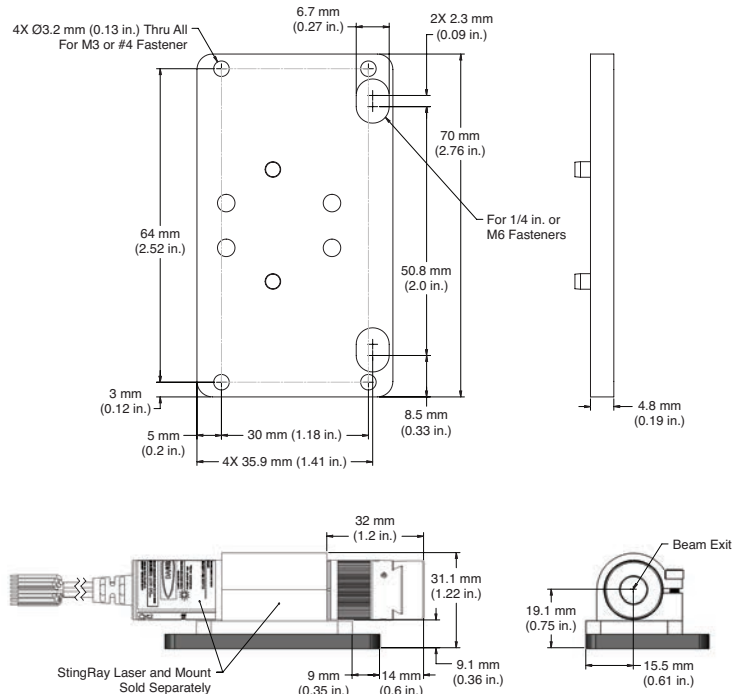
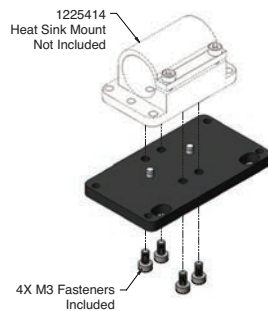

Heat Sink Mount Adapter with Heat Sink and StingRay Laser Installed

### StingRay Remote

Part Number: 1231404

The StingRay remote is meant to be used with lasers that include a Hirose connector. It includes a keyswitch, an interlock, the control software, and a power supply. Use with lasers that include a Hirose connector.

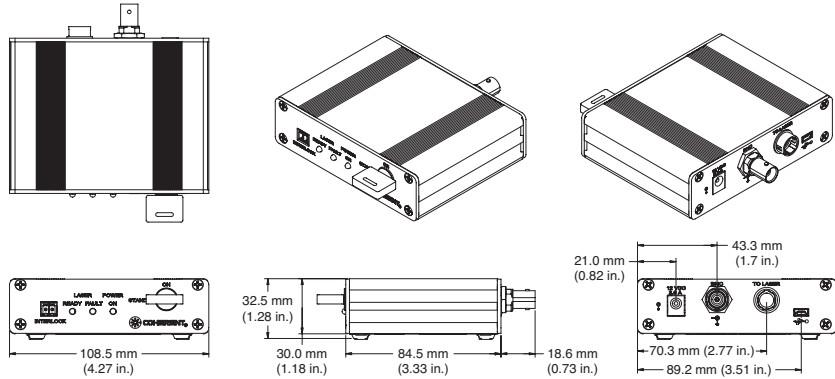

### StingRay 12 Pin Hirose Connector to Flying Lead Break Out

Part Number: 1229640

This convenient cable provides an easy break out of the I/O signals used by the StingRay laser family. When the laser uses the Hirose Connector, this mating connector can be used to quickly convert to Flying Lead with simple access to connecting to and receiving signals from a StingRay laser.

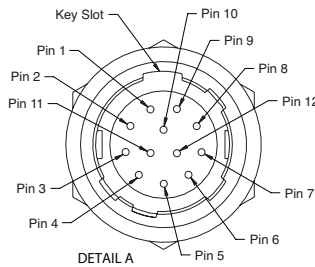
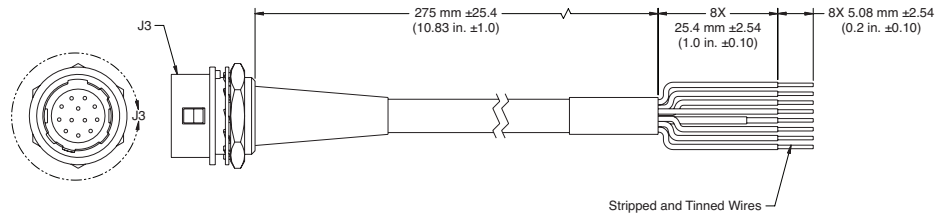

WIRE LIST				
SIGNAL NAME	FROM	TO	WIRE AWG	COLOR
VIN	J3-9	NC	28	RED
VIN GND	J3-1	NC	28	BLACK
COM RX	J3-4	NC	28	WHITE
COM GND	J3-5	NC	28	WHITE/BLACK
COM TX	J3-6	NC	28	ORANGE
FAULT	J3-10	NC	28	GREEN
VMOD	J3-2	NC	28	BLUE
VMOD GND	J3-3	NC	28	RED/BLACK
CABLE SHIELD	SHIELD	J3-1	-	BLACK
J3 CONNECTOR SHIELD	J3 SHIELD	NC	-	-



Coherent, Inc.,  
 5100 Patrick Henry Drive Santa Clara, CA 95054  
 p. (800) 527-3786 | (408) 764-4983  
 f. (408) 764-4646

tech.sales@coherent.com [www.coherent.com](http://www.coherent.com)

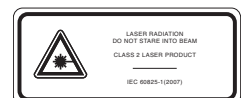
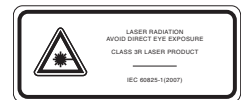

Coherent follows a policy of continuous product improvement. Specifications are subject to change without notice. Coherent's scientific and industrial lasers are certified to comply with the Federal Regulations (21 CFR Subchapter J) as administered by the Center for Devices and Radiological Health on all systems ordered for shipment after August 2, 1976.

Coherent offers a limited warranty for all StingRay and BioRay Lasers. For full details of this warranty coverage, please refer to the Service section at [www.coherent.com](http://www.coherent.com) or contact your local Sales or Service Representative. MC-010-17-0M1221Rev.G Copyright ©2021 Coherent, Inc.